





Endurance LED Panel p442

Oficinas



427

*Otto CCT LED
Suspended Linear*



428

*Millau LED
Suspended Linear*



429

*Vasco LED
Suspended Linear*

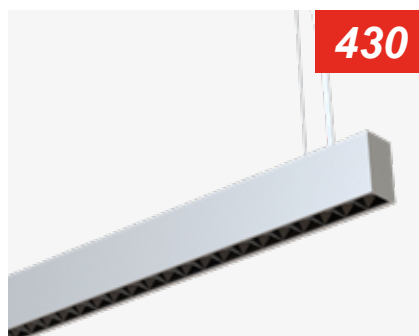

430

*Sidu LED
Suspended Linear*



431

*Eaves LED
Recessed Linear*



433

*Gemini LED
Surface Linear*



435

*Crescent LED
Surface Linear*



436

Suspended / Surface Linear



440

*Brooklyn LED
Bi-directional Panel*

441



*Spektrum LED CCT
Frame*

442



Recessed LED Panels

450



*Recessed LED
Panel Accessories*

452



*IP65 Defender LED
Recessed Clean Air*

453

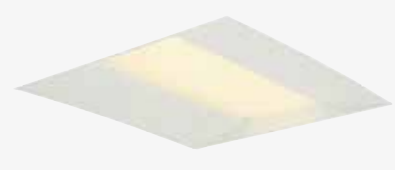

Lota LED Troffer

454



*Gridline Duo LED
Recessed Indirect*

455



*Venus LED
Recessed Indirect*

456

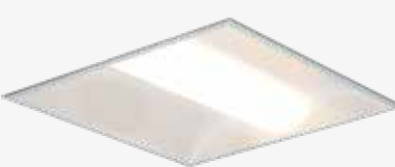

*Neptune CCT LED
Troffer*

457



Pluto LED



Diseñado para
Entregar...

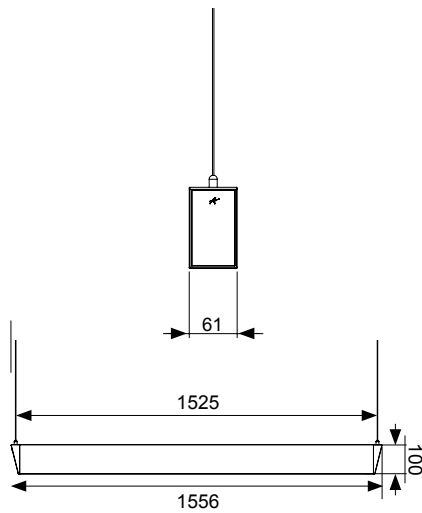
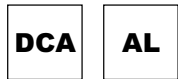
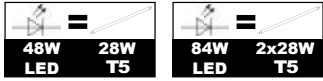
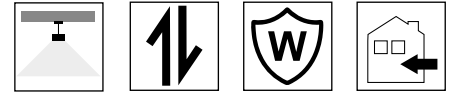

AOTLED5/CCT



AOTLED5/W/CCT

Se puede desconectar el foco ascendente para dar iluminación solo hacia abajo

W	45W	86W
Lm/D		
4000K	4052lm	7487lm
3000K	3861lm	7185lm
Lm/W		
4000K	92lm	86lm
3000K	86lm	84lm
CRI		Ra 80
CCT		4000K
		3000K
V		230V
Hz		50/60Hz
Temp		-25°C to 50°C

AOTLED5/CCT	LED	45W - 4000K/3000K
AOTLED2X5/CCT	LED	86W - 4000K/3000K
AOTLED5/W/CCT	LED	48W - 4000K/3000K
AOTLED2X5/W/CCT	LED	84W - 4000K/3000K

/M3		
/DD		(DD1/DD2/DD3/DD4)
/MWS		

Accesorios

AOTLED/90B	Conector de Esquina 90 grados
------------	-------------------------------

Millau LED Luminaria de superficie

Driver Incluido

428

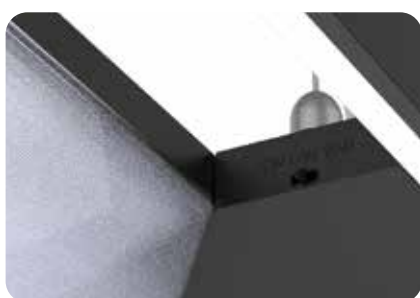
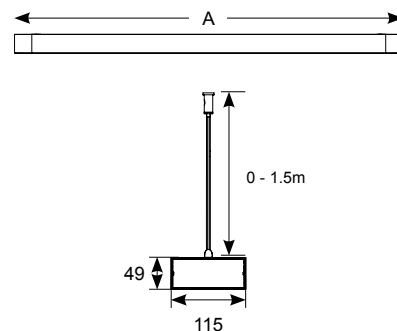
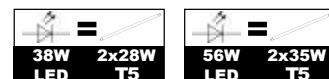

Interruptor integrado para la selección de la Temperatura de Color entre 3000K/4000K y 6000K



El diseño ahuecado proporciona una apariencia de producto ultra-moderna

			A
AMILLED4	LED	38W - 3000K/4000K/6000K	1222
AMILLED5	LED	56W - 3000K/4000K/6000K	1622

W	38W	56W
Lm/D		
4000K	3475lm	4419lm
3000K	3408lm	4290lm
6000K	3492lm	4394lm
Lm/W		
4000K	91lm	79lm
3000K	90lm	77lm
6000K	92lm	77lm
CRI	Ra 80	
CCT	4000K 3000K 6000K	
V	230V	
Hz	50Hz	
Temp	-20°C - 45°C	

Lineal suspendida Vasco LED CCT

Driver Incluido

429

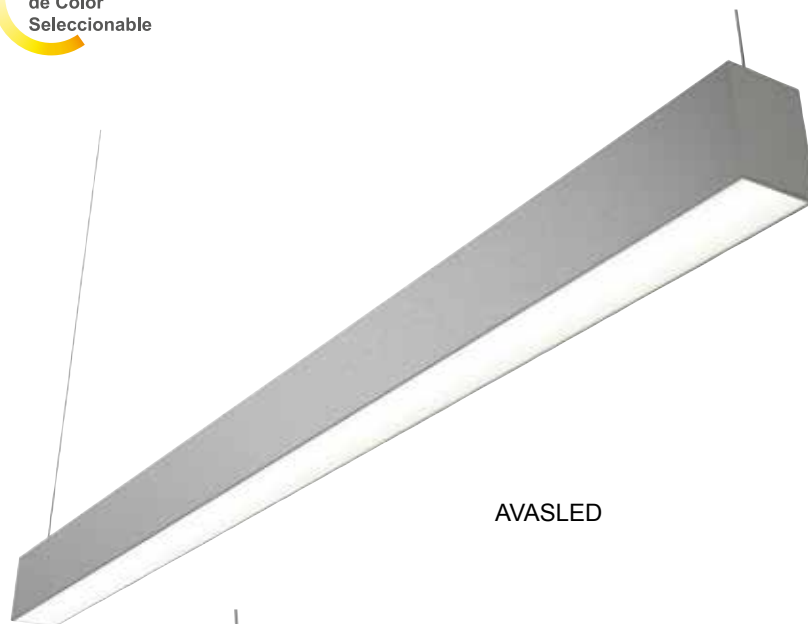
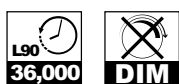
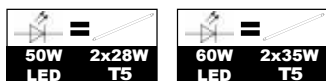

AVASLED

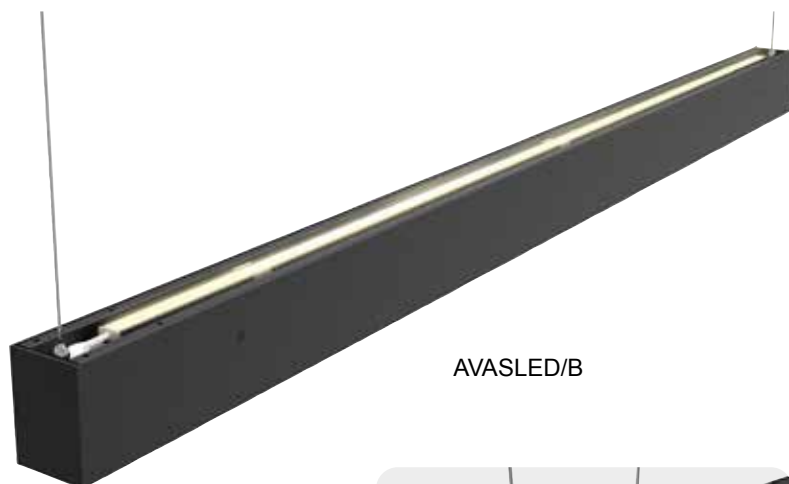

AVASLED/B



Conector Lineal para montaje en línea continua

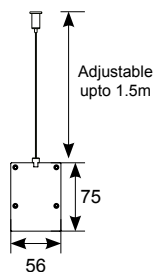
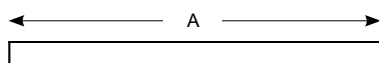

W	50W	60W
Lm/D		
3000K	4798lm	5308lm
4000K	5283lm	6405lm
6000K	4908lm	6075lm
Lm/W		
3000K	96lm	88lm
4000K	106lm	107lm
6000K	98lm	101lm
CRI	Ra 80	
CCT	4000K 3000K 6000K	
V	230V	
Hz	50Hz	
Temp	-20°C to 45°C	

					A
AVASLED	LED	50W - 3000K/4000K/6000K	● AI		1204
AVASLED/B	LED	50W - 3000K/4000K/6000K	● B		1204
AVASLED5	LED	60W - 3000K/4000K/6000K	● AI		1504
AVASLED5/B	LED	60W - 3000K/4000K/6000K	● B		1504

Accesorios

AVASLED/LC	Conector de enlace continuo
------------	-----------------------------



Lineal suspendida Sidu LED

Driver Incluido

430

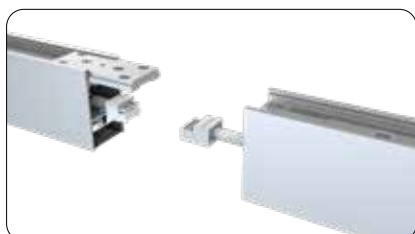
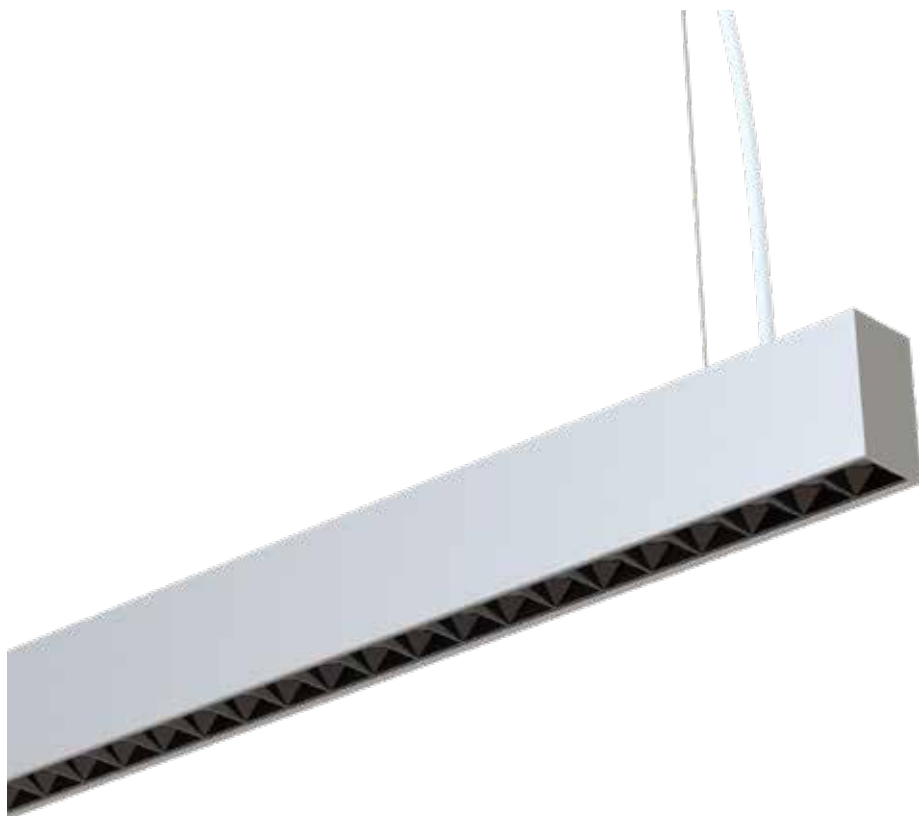

Fácil conexión para líneas continuas



Suspensión por cable

			A
ASIDLED/CW	LED	49W - 4000K	1175
ASIDLED5/CW	LED	60W - 4000K	1493

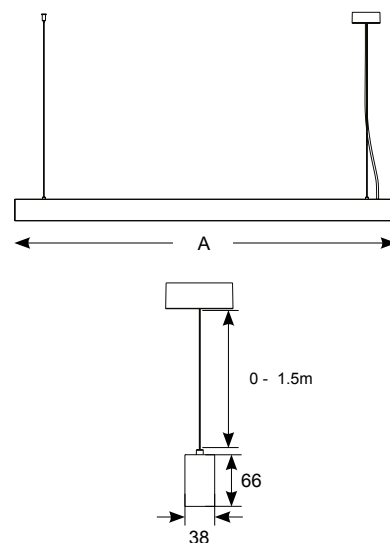
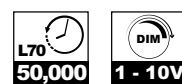
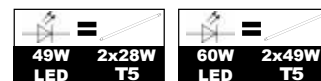

W	49W 60W
Lm/D	
49W	5209lm
60W	6762lm
Lm/W	
49W	106lm
60W	113lm
CRI	Ra 80
CCT	4000K
V	100/240V
Hz	50/60Hz
Temp	-20°C to 45°C

Eaves LED lineal empotrado

Driver externo

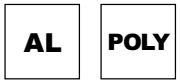
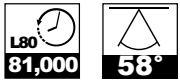
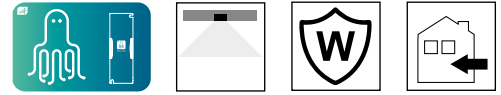

Microrreflector de policarbonato negro; su diseño reduce los reflejos

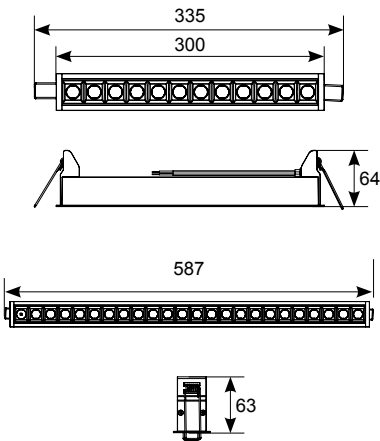

W	10W	15W
Lm/D		
4000K	954lm	1429lm
3000K	944lm	1402lm
Lm/W		
4000K	95lm	95lm
3000K	94lm	93lm
CRI	Ra 90	
CCT	3000K 4000K	
V	220-240V	
Hz	50/60Hz	
Temp	-25°C to 40°C	

AEVLED300/WB/CW	LED	10W - 4000K - 300mm
AEVLED300/WB/WW	LED	10W - 3000K - 300mm
AEVLED600/WB/CW	LED	15W - 4000K - 600mm
AEVLED600/WB/WW	LED	15W - 3000K - 600mm
/OCTO		
/DD		(DD1/DD2/DD3/DD4)



Luminaria de superficie Gemini LED

Driver Incluido

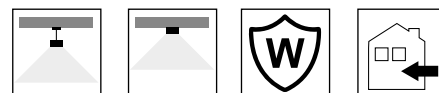

433



Powered by
TRIDONIC
▼ enlightening your ideas

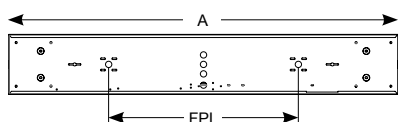
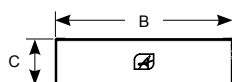

W	40W
	54W
Lm/D	
40W	4448lm
54W	5291lm
Lm/W	
40W	108lm
54W	98lm
CRI	Ra 80
CCT	4000K
V	220V-240V
Hz	50-60Hz
Temp	-20°C-50°C

				A	B	C	FPL
AGELED2X4	LED	40W		1230	190	55	600
AGELED2X5	LED	54W		1510	190	55	600

/M3		
/DD		(DD1/DD2/DD3/DD4)

Accesorios

ASK1	Kit de suspensión (1.3m)
-------------	--------------------------



Regletas de conexión rápida incorporadas

ST

Powered by
TRIDONIC
▼ enlightening your ideas

Placa LED de alto rendimiento

AL

POLY



Luminaria de superficie Crescent LED

Driver Incluido

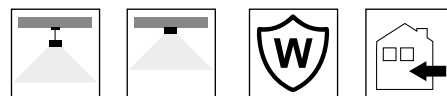

435

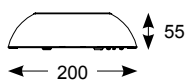

Powered by
TRIDONIC
enlightening your ideas



W	42W 51W
Lm/D	
2X4	4497lm
2X5	5266lm
Lm/W	
2X4	107lm
2X5	103lm
CRI	Ra 80
CCT	4000K
V	220V-240V
Hz	50Hz
Temp	-20°C to 50°C

			A	FPL
ACRESLED2X4	LED	42W - 4000K	1200	600
ACRESLED2X5	LED	51W - 4000K	1500	900

/M3		
/SM3		
/DM3		
/DD		(DD1/DD2/DD3/DD4)

Accesorios

ASK1	Kit de suspensión (1.3m)
-------------	--------------------------



Regleta Airbeam LED

Driver Incluido

436

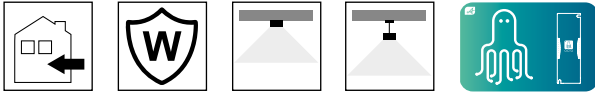

Powered by
TRIDONIC
▼ enlightening your ideas

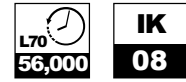
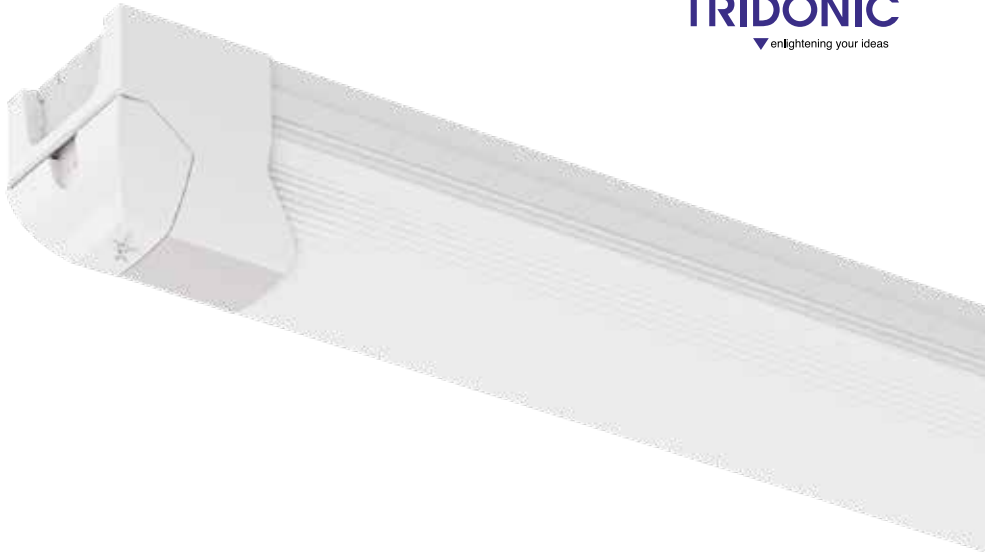

Tapa lateral de apertura a presión



Entrada de alimentación de 20 mm



Posibilidad de fijar la tapa lateral con tornillos



Posibilidad de montaje directo a techo

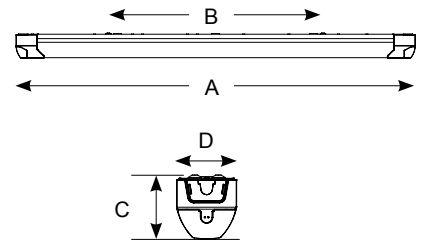

				A	B	C	D
ABLED4	LED	1 x 25W		1220	600	77	76
ABLED5	LED	1 x 34W		1525	600	77	76
ABLED6	LED	1 x 37W		1820	600	77	76
ABLED2X4	LED	1 x 48W		1220	600	77	76
ABLED2X5	LED	1 x 55W		1525	600	77	76
ABLED2X6	LED	1 x 70W		1820	600	77	76

/M3		
/OCTO		
/DD		(DD1/DD2/DD3/DD4 - ABLED2X6 Not Available)
/MWS		

W	25W	48W
	34W	55W
	37W	70W

Lm/D	2778lm	5517lm
	3608lm	6407lm
	4189lm	7910lm

Lm/W	116lm	106lm
	109lm	105lm
	100lm	94lm

CRI Ra 80

CCT 4000K

V 230V

Hz 50Hz

Temp 0°C to 25°C

Proline ED de superficie/suspendida

Driver Incluido

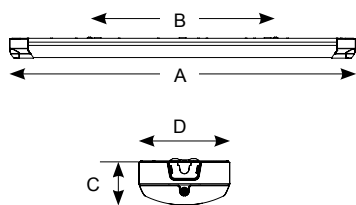
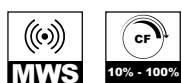
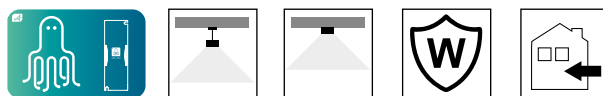

Tapa lateral de apertura a presión



Entrada de alimentación de 20 mm



Posibilidad de fijar la tapa lateral con tornillos



Posibilidad de montaje directo a techo

W	25W	49W
	33W	55W
	36W	70W
Lm/D	2496lm	5097lm
	3440lm	6090lm
	4316lm	8029lm
Lm/W	100lm	98lm
	104lm	100lm
	114lm	101lm
CRI	Ra 80	
CCT	4000K	
V	230V	
Hz	50Hz	
Temp	0°C to 25°C	

				A	B	C	D
APRLED4	LED	1 x 25W		1220	600	73	148
APRLED5	LED	1 x 33W		1525	600	73	148
APRLED6	LED	1 x 36W		1820	600	73	148
APRLED2X4	LED	1 x 49W		1220	600	73	148
APRLED2X5	LED	1 x 55W		1525	600	73	148
APRLED2X6	LED	1 x 70W		1820	600	73	148

/M3		
/OCTO		
/DD		(DD1/DD2/DD3/DD4 - APRLED2X6 Not Available)
/MWS		



Oxford ED de superficie/suspendida

Driver Incluido

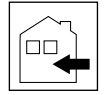
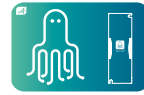

439

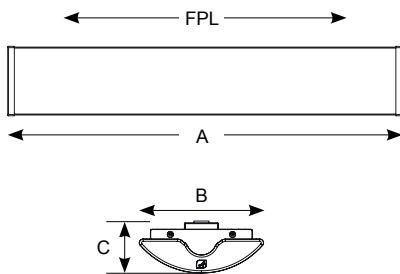
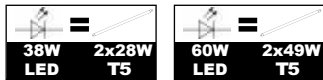

Powered by
TRIDONIC
▼ enlightening your ideas



W	23W	34W
	38W	60W
Lm/D	2944lm	3668lm
	4248lm	6552lm
Lm/W	128lm	108lm
	111lm	109lm
CRI	Ra 80	
CCT	4000K	
V	230V	
Hz	50/60Hz	
Temp	-20°C to 50°C	

				A	B	C	FPL
AOXLED4	LED	23W - 4000K		1190	165	70	1084
AOXLED5	LED	34W - 4000K		1470	165	70	1384
AOXLED2X4	LED	38W - 4000K		1190	165	70	1084
AOXLED2X5	LED	60W - 4000K		1470	165	70	1364

/M3		
/OCTO		
/DD		(DD1/DD2/DD3/DD4)



Luminaria Luz Directa/Indirecta Brooklyn LED

Driver Incluido

440



AL

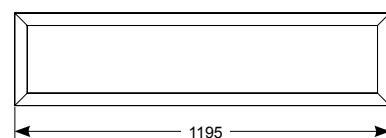
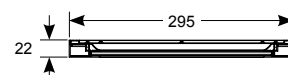

ABROLED LED 36W 4000K

W	36W
Lm/D	3788lm
Lm/W	105lm
CRI	Ra 80
CCT	4000K
V	100V-240V
Hz	50-60Hz
Temp	-20°C-40°C

Spektrum LED Luminaria empotrada con Temperatura de Color seleccionable

Driver Incluido

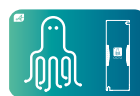

441



4000K



6500K



3000K

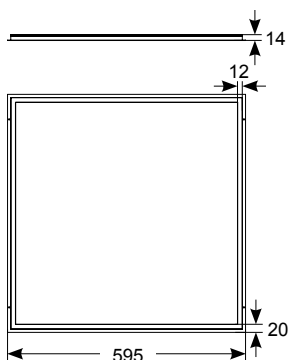

W	28W
Lm/D	
4000K	2995lm
3000K	2877lm
6500K	3000lm
Lm/W	
4000K	111lm
3000K	103lm
6500K	103lm
CRI	Ra 80
CCT	3000K
	4000K
	6500K
V	230V
Hz	50/60Hz
Temp	-20°C - 45°C

ASPELED/60/CCT	LED	28W - 3000K/4000K/6500K
/M3		
/SM3		
/DM3		
/OCTO		
/DD		(DD1/DD2/DD3/DD4)



Infinite LED Panel Empotrado

Driver Incluido

442

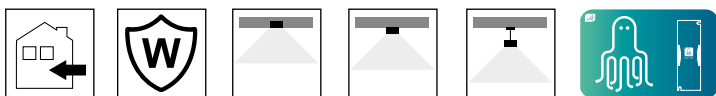

Powered by
TRIDONIC
▼ enlightening your ideas



AIRMLED/SMF
+ AIRMLED/POD/3NM/ST

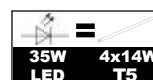

Dimensions (mm)
L595 x W595 x H10

See p450 for more information
on Panel Pod Emergency and
Panel Pod Sensor

AIRMLED/CW	LED	35W - 4750K
AIRMLED/POD/3NM/ST	LED	5W -
AIRMLED/POD/MWS		1W -
/OCTO		
/DD		(DD1/DD2/DD3/DD4)

Accesorios

AIRMLED/SMF	Montaje de Superficie de Cuadro (L600mmxW600mmxD75mm)
AIRMLED/PRK	Kit de Empotrar Carton de Yeso (Cut-out 615x615mm)
AERMLED/SK	2 Metro Kit de Suspensión
AEQTCC/600	Igualada 600x600 Regulador de Temperatura

W	35W
Lm/D	3300lm
Lm/W	94lm
CRI	Ra 80
CCT	4750K
V	230V
Hz	50Hz
Temp	-10°C to 40°C



Endurance LED TPa UGR<19 Panel Empotrado

Driver Incluido

444

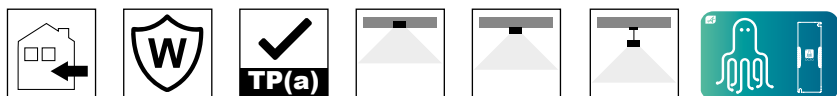

AERMLED3/60 Dimensions (mm)
L595 x W595 x H10

See p450 for more information
on Panel Pod Emergency and
Panel Pod Sensor

	AERMLED3/60/CW	LED	29W - 4000K
	AERMLED3/60/WW	LED	29W - 3000K
	AERMLED3/60/DL	LED	29W - 6000K

HO	AERMLED3/HO/60/CW	LED	29W - 4000K
	AERMLED3/HO/60/WW	LED	29W - 3000K
	AERMLED3/HO/60/DL	LED	29W - 6000K

	AIRMLED/POD/3NM/ST	LED	5W -
	AIRMLED/POD/MWS	1W -	

	/OCTO		
	/DD		(DD1/DD3)*

Accesorios

* DD2/DD4 también disponible con equipo de control

AIRMLED/SMF	Montaje de Superficie de Cuadro (L600mmxW600mmxD75mm)
AIRMLED/PRK	Kit de Empotrar Carton de Yeso (Cut-out 615x615mm)
AERMLED/SK	2 Metro Kit de Suspensión
AEQTCC/600	Igualada 600x600 Regulador de Temperatura

	29W	HO
Lm/D		
4000K	2953lm	3742lm
3000K	2873lm	3610lm
6000K	2938lm	3725lm
Lm/W 4000K	102lm	129lm
Lm/W 3000K	99lm	125lm
Lm/W 6000K	101lm	128lm
CRI	Ra 80	
CCT	4000K	
	3000K	
	6000K	
V	230V	
Hz	50Hz	
Temp	-20°C - 40°C	



Panel Pod Compatible

Convierta rápida y fácilmente un panel estandar en una luminaria con Kit de Emergencia auto testable o con Detector de Presencia



Philips CertaDrive LED driver

Placa de acero de 0.2 mm posterior que proporciona soporte y rigidez



0.188mm Lámina difusora que permite la máxima eficiencia de la luminaria

Lamina de lana de perla de 5mm para garantizar la correcta posición de todas las capas

Capa de 2mm MS LGP que garantiza una Temperatura de Color constante durante toda la vida útil de la luminaria

Placa de LED de última generación y alta eficiencia



Marco reforzado de acero lacado en polvo para una mayor rigidez



Endurance LED TPa Panel Empotrado

Driver Incluido

446

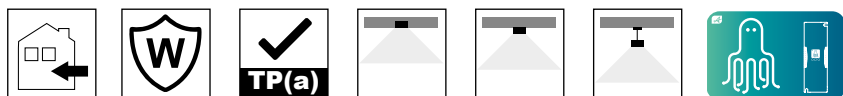

AERMLED/260 Dimensions (mm)
L595 x W595 x H10

See p450 for more information
on Panel Pod Emergency and
Panel Pod Sensor

AERMLED2/60/CW	LED	29W - 4000K
AERMLED2/60/WW	LED	29W - 3000K
AERMLED2/60/DL	LED	29W - 6000K

AIRMLED/POD/3NM/ST	LED	5W -
AIRMLED/POD/MWS	1W -	

/OCTO		
/DD		(DD1/DD3)*

Accesorios

* DD2/DD4 también disponible con equipo de control

AIRMLED/SMF	Montaje de Superficie de Cuadro (L600mmxW600mmxD75mm)
AIRMLED/PRK	Kit de Empotrar Carton de Yeso (Cut-out 615x615mm)
AERMLED/SK	2 Metro Kit de Suspensión
AEQTCC/600	Igualada 600x600 Regulador de Temperatura

W	29W
Lm/D	
4000K	3092lm
3000K	2891lm
6000K	3046lm
Lm/W 4000K	107lm
Lm/W 3000K	100lm
Lm/W 6000K	105lm
CRI	Ra 80
CCT	4000K
	3000K
	6000K
V	230V
Hz	50Hz
Temp	-20°C - 40°C



Endurance LED TPa Panel Empotrado

Driver Incluido

448

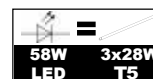

AERMLED/120 Dimensions (mm)
L1195 x W595 x H10

See p450 for more information
on Panel Pod Emergency and
Panel Pod Sensor

AERMLED2/120/CW	LED	58W - 4000K
AERMLED2/120/WW	LED	58W - 3000K
AERMLED2/120/DL	LED	58W - 6000K
AIRMLED/POD/3NM/ST	LED	5W -
AIRMLED/POD/MWS	1W -	
/DD		(DD1/DD2/DD3)
AERMLED/120/SMF	1200x600 Surface Mounting Frame	

W	58W
Lm/D	
4000K	5780lm
3000K	5363lm
6000K	5646lm
Lm/W 4000K	100lm
Lm/W 3000K	93lm
Lm/W 6000K	97lm
CRI	Ra 80
CCT	4000K
	3000K
	6500K
V	230V
Hz	50/60Hz
Temp	-20°C - 40°C

Endurance LED TPa Panel Empotrado

Driver Incluido

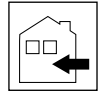

449



AERMLED2/30 Dimensions (mm)
L1195 x W295 x H10

See p450 for more information
on Panel Pod Emergency and
Panel Pod Sensor

W	29W
Lm/D	
4000K	3234lm
3000K	3187lm
6000K	3211lm
Lm/W 4000K	112lm
Lm/W 3000K	110lm
Lm/W 6000K	111lm
CRI	Ra 80
CCT	4000K
	3000K
	6500K
V	230V
Hz	50/60Hz
Temp	-20°C-40°C

AERMLED2/30/CW	LED	29W - 4000K
AERMLED2/30/WW	LED	29W - 3000K
AERMLED2/30/DL	LED	29W - 6000K

AIRMLED/POD/3NM/ST	LED	5W -
AIRMLED/POD/MWS	1W -	

/OCTO		
/DD		(DD1/DD2/DD3)

Accesorios

AERMLED/SK	Kit de suspensión (2m)
AERMLED/30/SMF	1200x300 Surface Mounting Frame



Panel Pod Emergencia y Panel Pod Detector de Presencia compatible con Infinite LED y Endurance LED

450

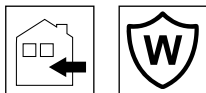

AIRMLED/POD/3NM/ST



- *Patente Británica. GB2522285*
- *Patente Europea No. 15165652.7*
- *Patente Irlandesa No. 2015/0128*
- *EC Diseño Registrado No 002712232-0001*

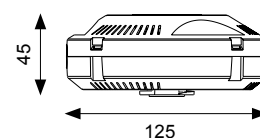

W	5W
Lm/D	189lm
CCT	6500K
V	220V-240V
Temp	0°C - 45°C



AIRMLED/POD/MWS

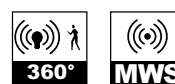

- *UK Patent Applied For No. 1504205.4*
- *EC Registered Design No 002712232-0001*

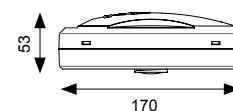

AIRMLED/POD/3NM/ST LED 5W 4000K

AIRMLED/POD/MWS 1W

Panel Pod



Precableado con un 1 metro de cable *

De serie para garantizar una instalación rápida y fácil.

* 300 mm de longitud en el caso del Detector de Presencia

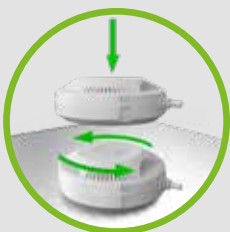

Conexión sin herramientas. Sistema "Gira y Bloquea".

Proporciona una conexión segura y facilita la instalación



Auto Test de serie *

Proporciona información instantánea del estado del módulo de emergencia, evitando los controles periódicos mensuales y anuales

* Solo en la versión Panel Pod Emergencia.



Área y Ángulo de detección

360° de Área y 120° de Ángulo de detección



** Only one Panel Pod can be attached to the back of individual panels**

Defender LED IP65 luminaria empotrada para ambientes limpios

Driver Incluido

452



Powered by
TRIDONIC
▼ enlightening your ideas

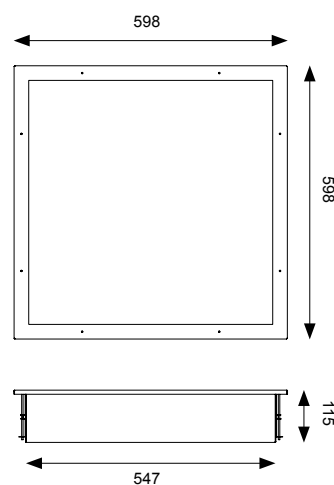
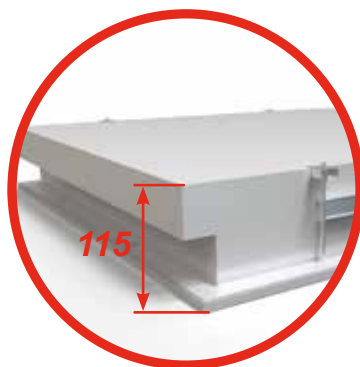

ADELED	LED	49W 4000K
--------	-----	-----------

/M3		
/DD		(DD1/DD2/DD3/DD4)

W	49W
Lm/D	4660lm
Lm/W	95lm
CRI	Ra 80
CCT	4000K
V	220V-240V
Hz	50-60Hz
Temp	-20°C - 50°C

Lota LED Luminaria empotrada indirecta

Driver Incluido

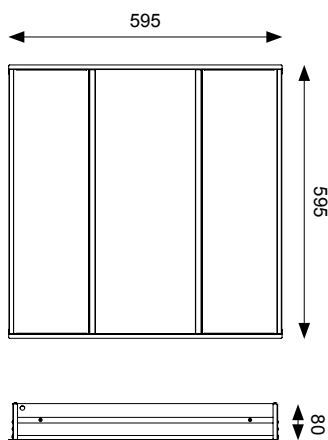
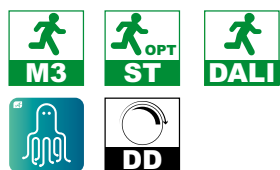

W	29W
Lm/D	
3000K	3051lm
4000K	3195lm
6000K	3178lm
Lm/W	
3000K	105lm
4000K	110lm
6000K	110lm
CRI	Ra 80
CCT	3000K
	4000K
	6000K
V	230V
Hz	50/60Hz
Temp	-10°C - 40°C



4000K



6000K



3000K

ALOTLED	LED	29W - 3000K / 4000K / 6000K
/M3		
/SM3		
/DM3		
/OCTO		
/DD		(DD1/DD2/DD3/DD4)



Gridline duo LED luminaria empotrada indirecta

Driver Incluido

GRIDLINE™
DUO

454



Powered by
TRIDONIC
▼ enlightening your ideas



AGDLED/BLA

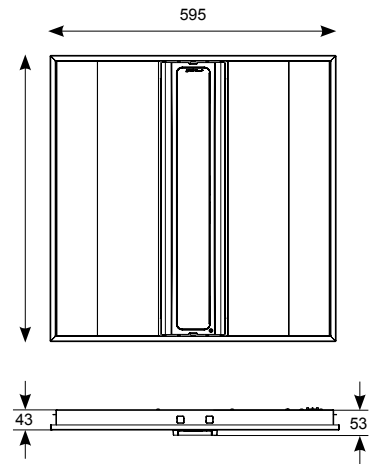
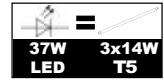

AGDLED	LED	37W 4000K
--------	-----	-----------

/M3		
/DD		(DD1/DD2/DD3/DD4)
/MWS		

Accesorios

AGDLED/WLA		WLA
AGDLED/BLA		BLA
AIRMLLED/PRK	Kit de Empotrar Carton de Yeso (Cut-out 608x608mm)	

W	37W
Lm/D	3300lm
Lm/W	89lm
CRI	Ra 80
CCT	4000K
V	220V-240V
Hz	50Hz
Temp	0°C - 25°C

Venus LED empotrada indirecta

Driver Incluido

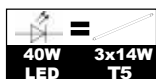
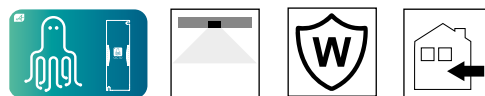

Powered by
TRIDONIC
▼ enlightening your ideas

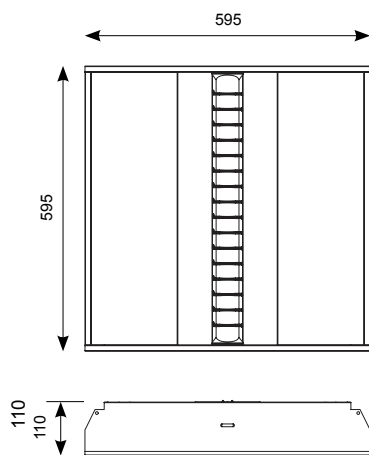

W	40W
Lm/D	3926lm
Lm/W	98lm
CRI	Ra 80
CCT	4000K
V	220V-240V
Hz	50-60Hz
Temp	-20°C - 50°C

AVENLED	LED	40W 4000K
/M3		
/OCTO		
/DD		(DD1/DD2/DD3/DD4)



Luminaria empotrada indirecta Neptune LED con Temperatura de Color seleccionable

Driver Incluido

456

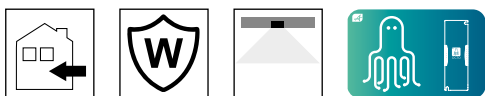

4000K



6000K

Powered by
TRIDONIC
enlightening your ideas

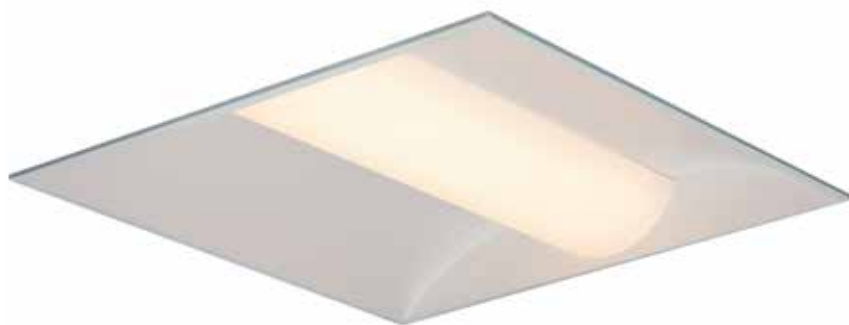

3000K

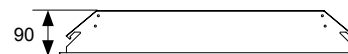
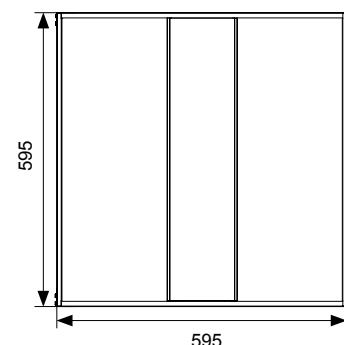
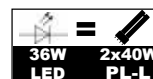

W	36W
Lm/D	
3000K	3564lm
4000K	3796lm
6000K	3767lm
Lm/W	
3000K	99lm
4000K	108lm
6000K	102lm
CRI	Ra 80
CCT	
	3000K
	4000K
	6000K
V	230V
Hz	50/60Hz
Temp	-20°C - 45°C

ANEPLD	LED	36W 3000K/4000K/6000K
--------	-----	-----------------------

/M3		
/OCTO		
/DD		(DD1/DD2/DD3/DD4)

Pluto LED luminaria empotrada indirecta

Driver Incluido

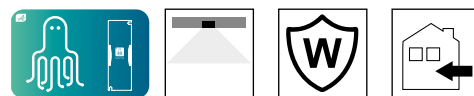

457

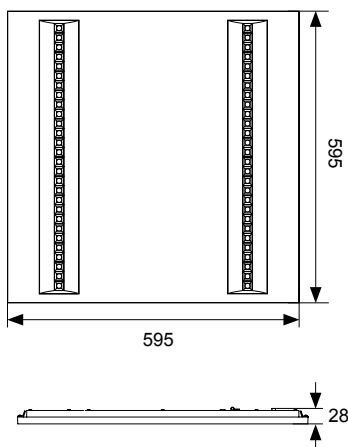

Powered by
TRIDONIC
▼ enlightening your ideas

W	35W
Lm/D	3591lm
Lm/W	112lm
CRI	Ra 80
CCT	4000K
V	230V
Hz	50/60Hz
Temp	-20°C - 45°C

APLUED	LED	35W 4000K
/M3		
/OCTO		
/DD		(DD1/DD2/DD3/DD4)

