





Z LED High Bay UFO p405



Deco LED High Bay



*Z LED
High Bay UFO*



ForceLINE LED



Opti-Lux LED Linear



*Pre-Wired T8 Non-
Corrosive for LED Tubes*



*Stormloc LED
Non-Corrosive*

412



*Tornado Pro LED
Non-Corrosive*

414



*Tornado LED
Non-Corrosive*

416



*Tornado LED 110V
Non-Corrosive*

417



*Sleek LED 110V
Bulkhead*

419

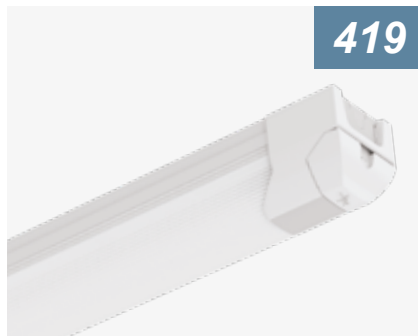

Airbeam LED Batten

420



Topline 6 LED Batten

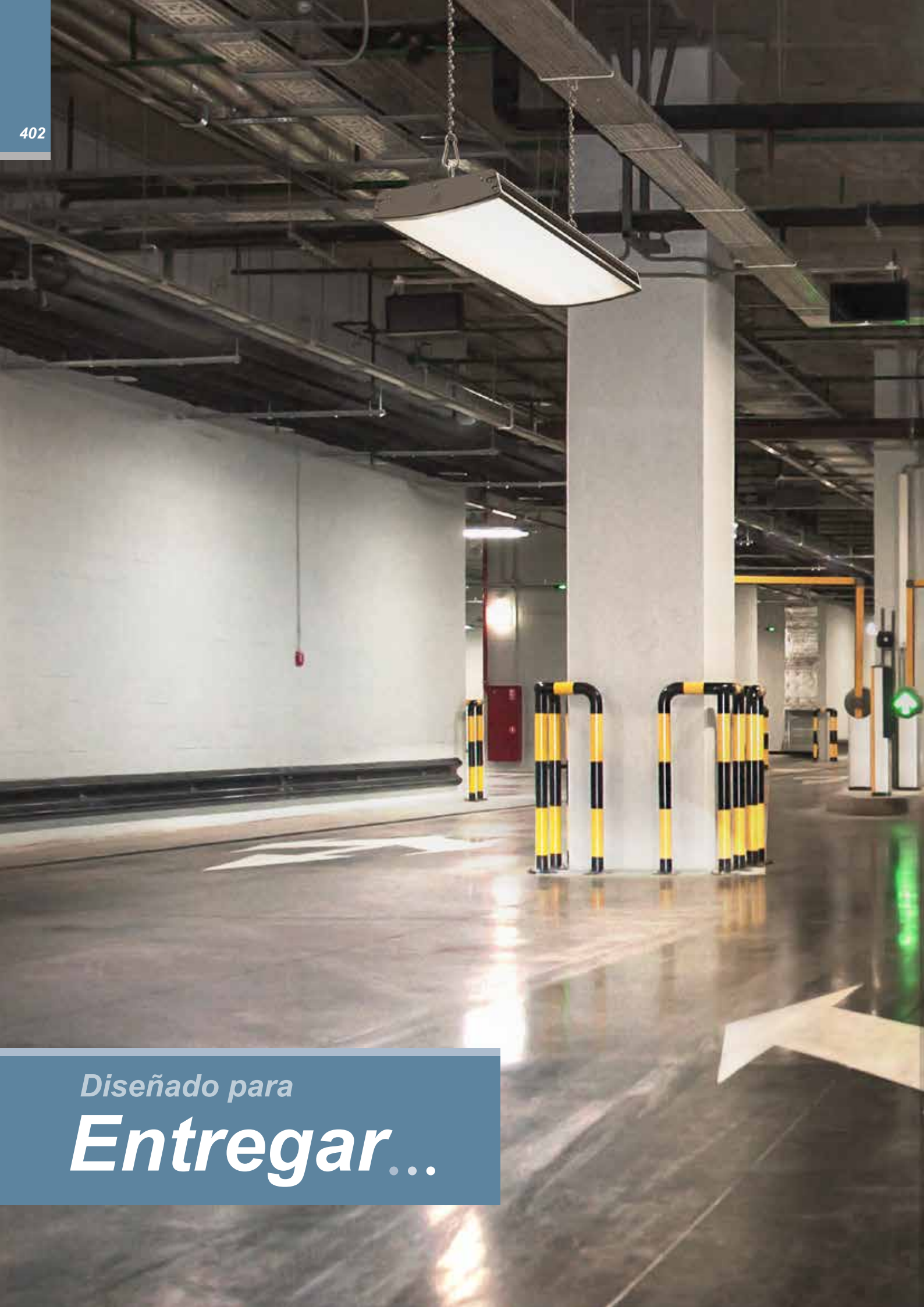

Diseñado para
Entregar...

Campana Industrial Deco LED

Driver Incluido

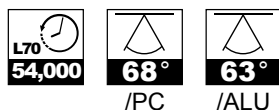
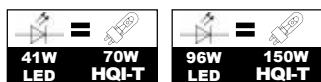

ADHBLED1/PC

Powered by
TRIDONIC
enlightening your ideas



ADHBLED2/ALU

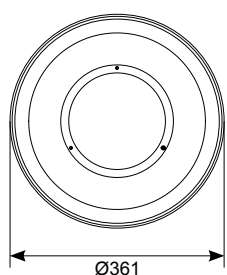
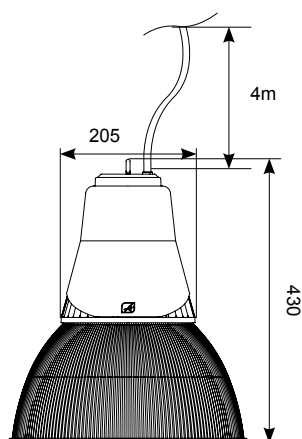

W	41W	96W
Lm/D		
/ALU	4760lm	10437lm
/PC	4678lm	10375lm
Lm/W		
/ALU	114lm	109lm
/PC	116lm	108lm
CRI		Ra 80
CCT		4000K
V		230V
Hz		50/60Hz
Temp		-20°C - 25°C

ADHBLED1/PC	LED	41W -	POLY
ADHBLED2/PC	LED	96W -	POLY

ADHBLED1/ALU	LED	41W -	AL
ADHBLED2/ALU	LED	96W -	AL

/DD		(DD1/DD2/DD3/DD4)
-----	--	-------------------

Accesorios

ADHBLED/PC/BC	Tapa protectora inferior de policarbonato translucido (360mm)
ADHBLED/SK	Kit de Suspensión



Z LEDTM UFO



Accesorio de anclaje incluido para facilitar la instalación

**IK
08**

DCA

DCA

Placa LED Bridgelux de alto rendimiento

Si

POLY

**AISI
316L**

Z LED UFO Código del Producto	Z LED UFO Lúmenes entregadas	HID Equivalente Tipo de Lampara	HID Lúmenes Equivalentes	HID Lúmenes entregadas (65% DLOR)
AZLED/1	11858lm	150W HQI-E	13,300lm	8645lm
AZLED/2	18443lm	250W HQI-E	23,800lm	15470lm
AZLED/3	23965lm	400W HQI-E	41,000lm	26650lm

Las fuentes de luz convencionales no aprovechan de manera eficiente el flujo lumínico, ya que gran parte de la luz es dirigida hacia la parte superior donde no es necesaria. Esto supone que la cantidad de luz emitida hacia abajo, lo que significa que puede ser aprovechada, sea aproximadamente de un 65%. Por el contrario, las fuentes de luz LED proyectan toda la luz en una sola dirección, lo que permite un aprovechamiento del 100%.



Ovni Z LED

Driver Incluido

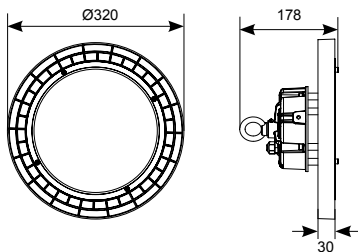
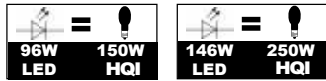

AZLED/1 + AZLED/2

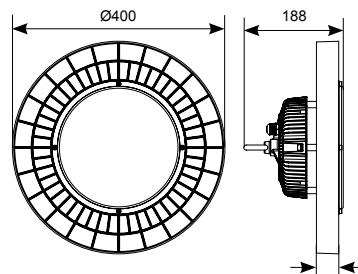

AZLED/3



AZLED/REF



AZLED/FB1



AZLED/MWSP



AZLED/MWS

Sensor de Microondas

- Caja con clasificación IP65
- 3M – 15M Altura de montaje ideal para cualquier altura de montaje de nivel bajo a alto
- Atenuación automática de 1-10V con retraso de tiempo y niveles de atenuación preestablecidos para seleccionar
- Sensor de luz diurna incorporado para un ahorro de energía mejorado mediante la recolección de luz diurna
- La puesta en marcha por interruptor o control remoto permite una programación versátil del sensor; Las opciones incluyen, Tiempo de espera, Nivel de atenuación en espera, Sensor de luz diurna y muchos más

W	96W	
	146W	
	197W	
Lm/D	4000K	6500K
96W	12090lm	12593lm
146W	19224lm	19064lm
197W	25292lm	26409lm
Lm/W		
96W	128lm	130lm
146W	131lm	127lm
197W	128lm	129lm
CRI	Ra 80	
CCT	4000K	
	6500K	
V	200V-240V	
Hz	50/60Hz	
Temp	-40°C to 40°C	

AZLED/1	LED	96W - 4000K
AZLED/2	LED	146W - 4000K
AZLED/3	LED	197W - 4000K

AZLED/1/DL	LED	98W - 6500K
AZLED/2/DL	LED	151W - 6500K
AZLED/3/DL	LED	198W - 6500K

/M3		
/MWS		

AZLED/REF	Reflector de Aluminio
AZLED/FB1	Soporte para montaje en superficie
AZLED/MWSP	Programador de sensores de microondas de High Bay



ForceLINE LED

Driver Incluido

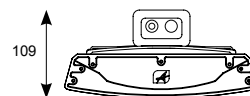
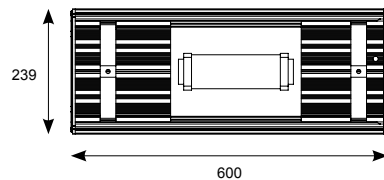
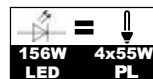

AFLLED2	LED	156W - 4000K
/M3		
/SM3		
/DM3		
/DD		(DD1/DD3/DD4)
/MWS		

W	156W
Lm/W	15474lm
Lm/W	99lm
CRI	Ra 80
CCT	4000K
V	230V
Hz	50Hz
Temp	-20°C - 50°C

FORCE LINE LED



Hytronik detector de presencia de alta frecuencia

Rango de tiempo: 5secs - 30mins

LUX: 2 - 50 lux

Area de detección: 12m

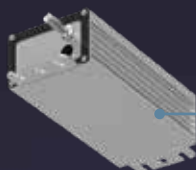
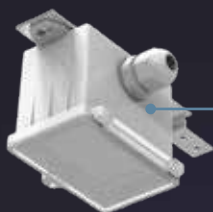

Driver Philips Xitanium incluido

DCA

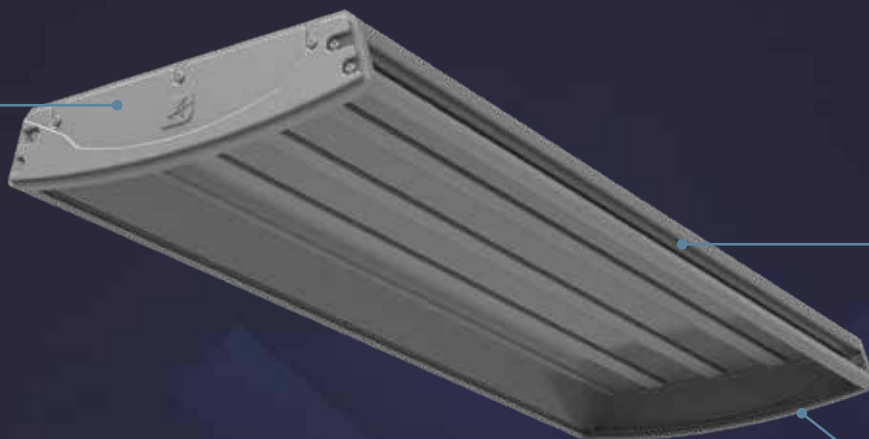

DCA



Placas LED de última generación para un rendimiento excepcional



IP
65



POLY



Opti-Lux LED Linear

Driver Incluido



AOLEDL55

Powered by
TRIDONIC
▼ enlightening your ideas



AOLEDL80

Kit de suspensión de 3 metros incluido

			A	B	C
AOLEDL55	LED	92W 4000K	615	410	120
AOLEDL80	LED	160W 4000K	1455	410	120
AOCONTROLLER		Mando a distancia para el Detector de Presencia			

/M3		
/DD		(DD1/DD2/DD3/DD4)
/SEN1		
/SEN3		

Accesorios

AOLEDL55/WG	Rejilla metálica protectora (615mm)
AOLEDL80/WG	Rejilla metálica protectora (1455mm)

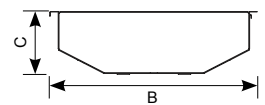
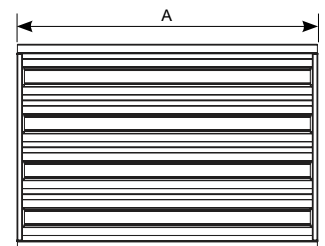
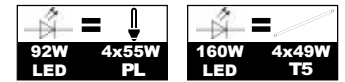

W	92W
	160W
Lm/D	
92W	12386lm
160W	19236lm
Lm/W 92W	135lm
Lm/W 160W	120lm
CRI	Ra 80
CCT	4000K
V	220-240V
Hz	50-60Hz
Temp	-20°C - 50°C

Precableado Anti Corrosión para tubos LED T8

Lámpara No Incluida

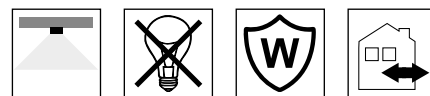

409



POLY

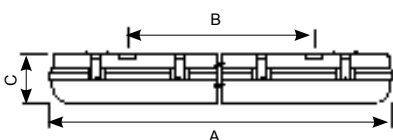

			A	B	C	D	Clips
ADP2	LED	1 x 600mm	655	478	110	105	4
ADP4	LED	1 x 1200mm	1265	907	110	105	8
ADP5	LED	1 x 1500mm	1565	907	110	105	10
ADP2X2	LED	2 x 600mm	655	478	110	165	4
ADP2X4	LED	2 x 1200mm	1265	907	110	165	8
ADP2X5	LED	2 x 1500mm	1565	907	110	165	10



StormlocTM

ELEMENT PROTECTION **LED**

Montaje de caja BESA

POLY

SS

TRIDONIC

DD

MWS

AL

**L70
56,000**

POLY



Stormloc IP65 LED Non-Corrosive

Supplied c/w Integral Driver

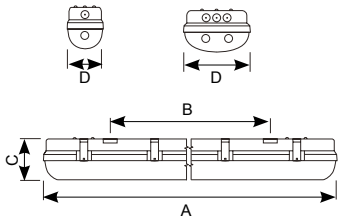

W	20W	39W
	29W	58W
	46W	86W
Lm/D	2440lm	4698lm
	3534lm	6978lm
	3652lm	7109lm
Lm/W	122lm	120lm
	122lm	120lm
	79lm	83lm
CRI	Ra 80	
CCT	4000K	
V	230V	
Hz	50Hz	
Temp	-20°C to 40°C	

			A	B	C	D
ASLED4	LED	20W	1265	907	110	105
ASLED5	LED	29W	1565	907	110	105
ASLED6	LED	46W	1858	1170	110	105
ASLED2X4	LED	39W	1265	907	110	165
ASLED2X5	LED	58W	1565	907	110	165
ASLED2X6	LED	86W	1858	1170	110	165

/M3		
/DD		(DD1/DD2/DD3/DD4)
/MWS		



Tornado Pro LED Non-Corrosive

Driver Incluido

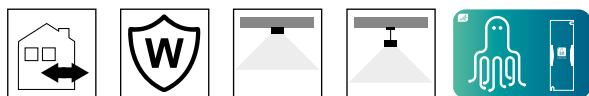

Tornado Pro
ELEMENT PROTECTION LED



Powered by
TRIDONIC
enlightening your ideas

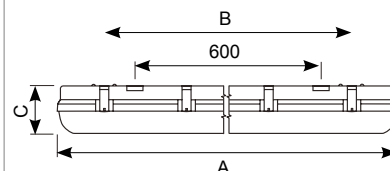

			A	B	C	D
ATORPLED4	LED	20W	1265	860	70	85
ATORPLED5	LED	29W	1565	960	70	85
ATORPLED6	LED	35W	1865	1200	70	85
ATORPLED2X4	LED	41W	1265	860	70	115
ATORPLED2X5	LED	61W	1565	960	70	115
ATORPLED2X6	LED	78W	1865	1200	70	115

/M3		
/DM3		
/OCTO		
/DD		(DD1/DD2/DD3/DD4)
/MWS		

W	20W	41W
	29W	61W
	35W	78W
Lm/D	2331lm	4457lm
	3209lm	6314lm
	3702lm	8204lm
Lm/W	117lm	109lm
	111lm	104lm
	106lm	105lm
CRI		Ra 80
CCT		4000K
V		230V
Hz		50Hz
Temp		-10°C to 40°C

Tornado Pro

ELEMENT PROTECTION LED



Tornado LED Anti Corrosión

Driver Incluido

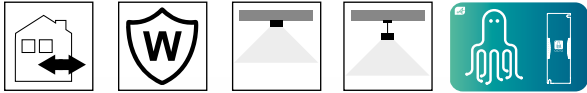

Stainless Steel Clips as standard

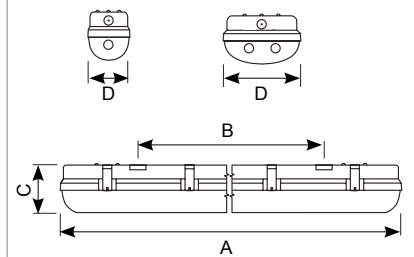

				A	B	C	D
ATORLED4	LED	20W		1266	860	75	85
ATORLED5	LED	28W		1566	960	75	85
ATORLED6	LED	35W		1866	1030	80	85
ATORLED2X4	LED	40W		1266	860	75	118
ATORLED2X5	LED	58W		1566	960	75	118
ATORLED2X6	LED	71W		1855	1030	80	118

/M3		
/OCTO		
/DD		(DD1/DD2/DD3/DD4)
/MWS		

W	20W	40W
	28W	58W
	35W	71W
Lm/D	2088lm	4425lm
	3230lm	6353lm
	3823lm	7320lm
Lm/W	104lm	110lm
	115lm	110lm
	109lm	103lm
CRI	Ra 80	
CCT	4000K	
V	230V	
Hz	50Hz	
Temp	-10°C to 40°C	



Tornado LED 110 V Anti Corrosión

Driver Incluido



Clips de Acero Inoxidable incluidos

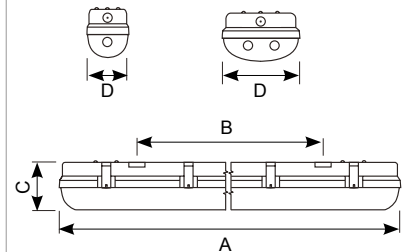

			A	B	C	D
ATORLED2/110V	LED	10W	656	360	75	85
ATORLED4/110V	LED	20W	1266	860	75	85
ATORLED5/110V	LED	28W	1566	960	75	85
ATORLED2X2/110V	LED	20W	656	360	75	118
ATORLED2X4/110V	LED	40W	1266	860	75	118
ATORLED2X5/110V	LED	58W	1566	960	75	118

/M3	
/MWS	

W	10W	20W
	20W	40W
	28W	58W
Lm/D	1164lm	2297lm
	2088lm	4225lm
	3230lm	6353lm
Lm/W	118lm	118lm
	104lm	110lm
	115lm	110lm
CRI		Ra 80
CCT		4000K
V		100/240V
Hz		50Hz
Temp		-10°C - 40°C

Aplique Sleek LED 110 V

Driver Incluído



417

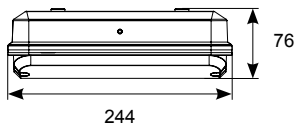
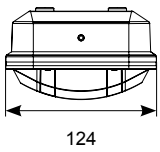

ASLED/DIFF/RED

W	5W
Lm/D	424lm
Lm/W	85lm
CRI	Ra 80
CCT	4000K
V	110V
Hz	50Hz
Temp	-10°C - 40°C

ASBLED/110V	LED	5W	
/PC			
/MWS			

Accesorios

ASBLED/DIFF/RED		
-----------------	--	--



Características de instalación



Tapa lateral de apertura a presión



Entrada de alimentación de 20 mm



Posibilidad de fijar la tapa lateral con tornillos

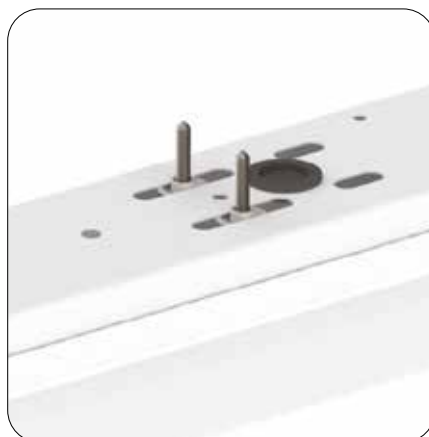

Posibilidad de montaje directo a techo

- *Push and release end cap for quick access*

- *Connection option via 20mm conduit entry*

- *Optional fixing through end cap if required*
- *BESA box fixing as standard*

- *Unique ceiling mounting 'shunt' facility provides installer with flexibility and ease of adjustment when continuous mounting*

Regleta Airbeam LED

Driver Incluido

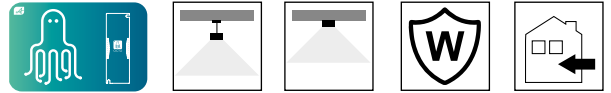

419

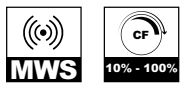

Powered by
TRIDONIC
enlightening your ideas

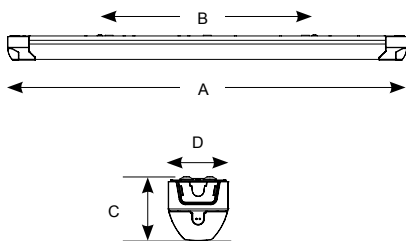

W	24W	52W
	33W	61W
	42W	84W
Lm/D	2778lm	5517lm
	3608lm	6407lm
	4189lm	7908lm
Lm/W	116lm	106lm
	109lm	105lm
	100lm	94lm
CRI	Ra 80	
CCT	4000K	
V	220V-240V	
Hz	50Hz	
Temp	0°C - 25°C	

			A	B	C	D
ABLED4	LED	1 x 24W	1220	600	77	76
ABLED5	LED	1 x 33W	1525	600	77	76
ABLED6	LED	1 x 42W	1820	600	77	76
ABLED2X4	LED	1 x 52W	1220	600	77	76
ABLED2X5	LED	1 x 61W	1525	600	77	76
ABLED2X6	LED	1 x 84W	1820	600	77	76

/M3		
/OCTO		
/DD		(DD1/DD2/DD3/DD4)
/MWS		



Regleta Topline 6 LED

Driver Incluido

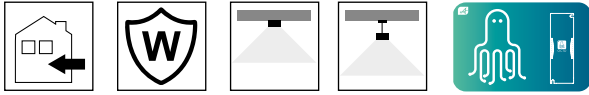

Powered by
TRIDONIC
▼ enlightening your ideas

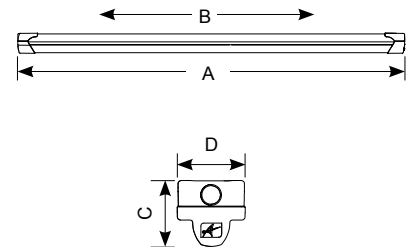
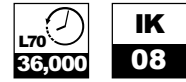

				A	B	C	D
ATLLED4	LED	26W - 4000K		1220	600	65	65
ATLLED5	LED	34W - 4000K		1525	600	65	65
ATLLED6	LED	41W - 4000K		1745	600	65	65
ATLLED2X4	LED	47W - 4000K		1220	600	65	65
ATLLED2X5	LED	61W - 4000K		1525	600	65	65
ATLLED2X6	LED	72W - 4000K		1745	600	65	65

/M3		
/MWS		
/OCTO		
/DD		(DD1/DD2/DD3/DD4)

W	26W	47W
	34W	61W
	41W	72W
Lm/D	2616lm	4939lm
	3656lm	6325lm
	4814lm	8232lm
Lm/W	100lm	105lm
	107lm	103lm
	117lm	114lm
CRI	Ra 80	
CCT	4000K	
V	220/240V	
Hz	50Hz	
Temp	-10°C to 40°C	

TOP LINE 6™

LED Batten

